

FUJITEC

REXIA

Machine-Room-Less Elevator

In Compliance With the Standards of EN81-20 and EN81-50

PRODUCT CONCEPT



“Made in Fujitec”

By providing people with the safe and reliable elevators that Fujitec manufactures in-house, Fujitec is building trust with people around the world.

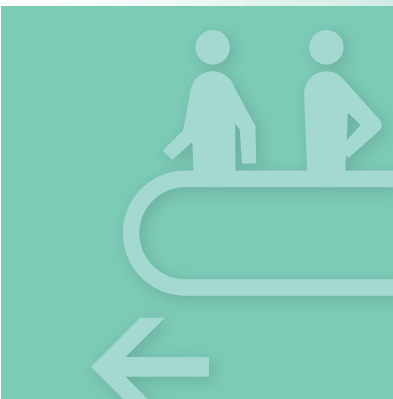
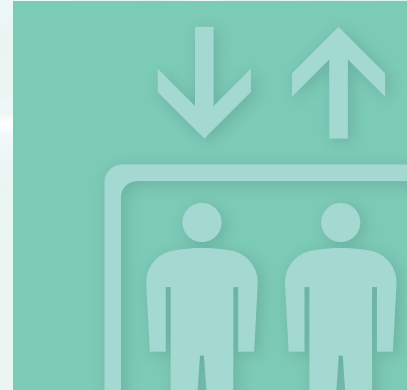
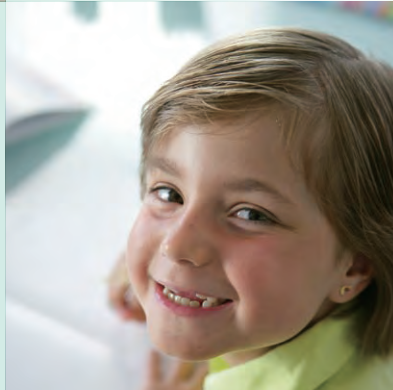

**By manufacturing safe and reliable elevators,
we are building trust with people around the world.**

Fujitec’s “Global Common Components” are used in the REXIA brand. The quality of components, such as traction machines, elevator controllers, and operating fixtures, is controlled through Fujitec’s integrated system of global quality management. Elevators with the same high quality will be provided by Fujitec’s global production base under the concept of “Made in Fujitec”.

More than 70-Year History in the Business of Elevator, Escalator and Moving Walks

Since the foundation of Fujitec in 1948, seeing the market from a global perspective and having the spirit of being a top global company, Fujitec has been a global leading manufacturer of elevators, escalators, and moving walks. Fujitec has been providing the people with leading-edge technologies and global standards of product.

PRODUCT CONCEPT

Safety & Reliability

All control-related components ranging from control circuits to inverters are independently developed by Fujitec, so that highly reliable elevator operation is established. When the elevator control system assembled with Fujitec's reliable component parts detects the possibility of the occurrence of elevator malfunction, it operates in order to maintain the elevator operation stable and efficient.



Ecology

In REXIA elevators, the gearless traction machines with a permanent magnetic synchronous motor assure low power consumption. Also, the electric power regenerative unit equipped between the elevator controller and the power supply saves the electrical energy consumption in the building. Fujitec contributes to global society by providing for ecology-conscious products, reflecting on them 70 years of knowledge and technologies accumulated through the manufacturing of elevators.



Comfort Design

Under Fujitec's universal designs, newly adopted buttons for elevator operating fixtures are highly visible and tactually recognizable, and the numbers and letters shown on aesthetically refined displays can be easily seen and read. Also, various styles for the decoration of elevator interior and landing floors provide the passengers with a superb and comfortable riding experience.



Contents

Safety & Reliability	5
Ecology	9
Comfort Design	11
Car Design	13
Color and Pattern Variations	21
Ceiling Design	23
Options	24
Entrance Design	25
EN81-70 Requirements	26
Car Operating Boards	27
Hall Fixtures	29
Specification Details	31
Work by Others	36
Global Operations	38

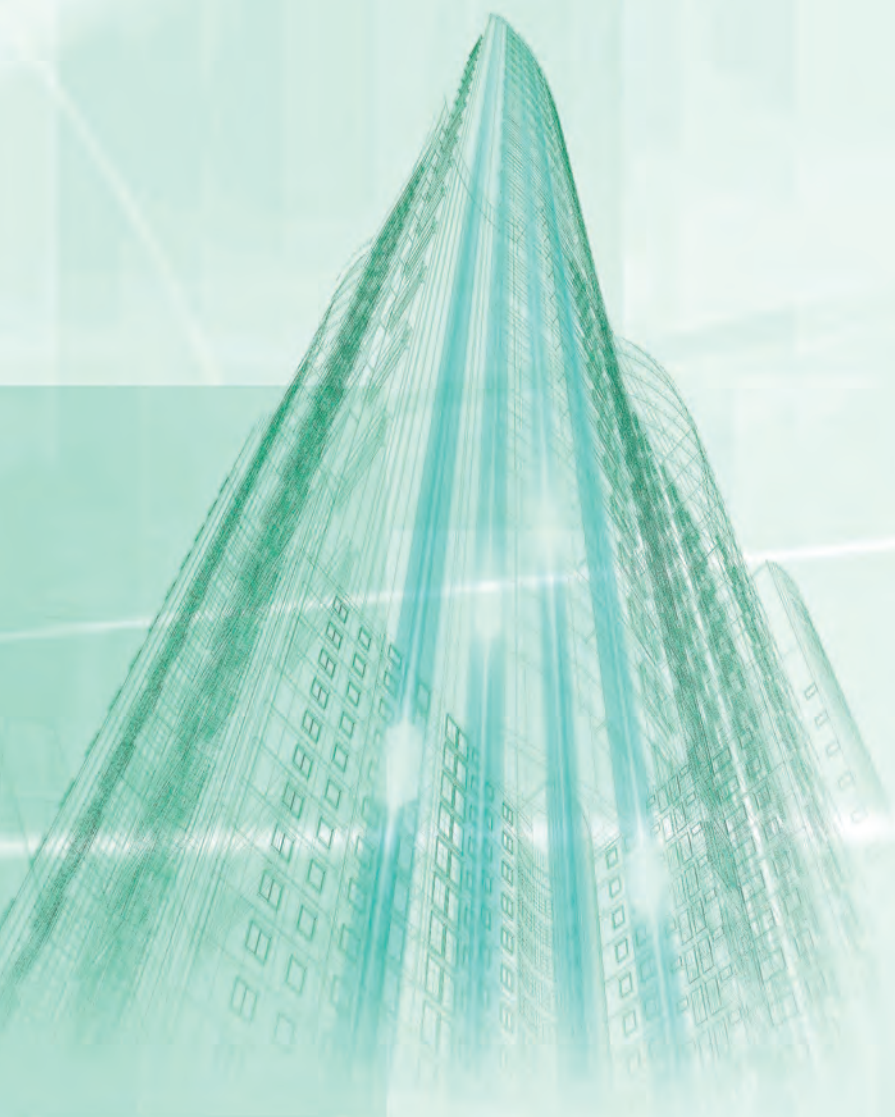

Capacity (kg)	SPEED (m/s)				
	1.0	1.5	1.75	2.0	2.5
450					
630					
800					
1000					
1200					
1275					
1350					
1600					
1800					
2000					

Note: Application of capacity and speed may differ due to specification.

Distributed Control System

COP: Control Panel
 COB: Car Operating Board
 MIC: Microcomputer
 IN: Hall Indicator

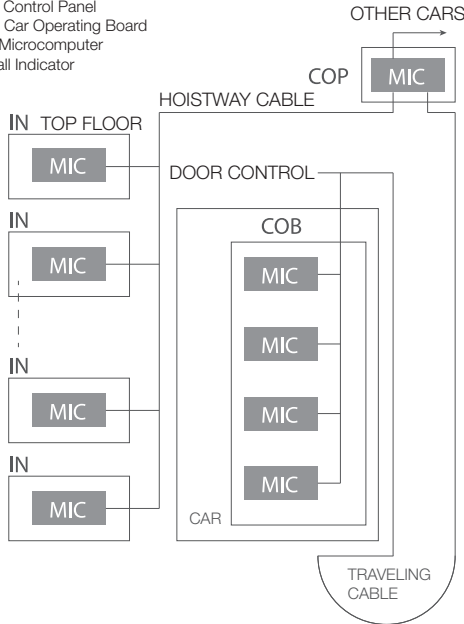

- A 32-bit data bus provides high-speed and high-precision data transmission of input-output command signals between each microprocessor located in control panels, hall-call / car-call buttons, hall indicators and hall lanterns
- High-speed data transfer with multiple protocols enables large-scale data processing at ten times the normal speed. This also improves the ability to monitor elevator running speed, landing precision and operating reliability as well as input-output command signals of car operating fixtures and operation indicators.
- The bus system is employed for data transmission between microcomputers located in every hall-call fixture, car operating board, and control panel. This bus system has strong protection against signal interference and has system-extending capability.



An elevator operation system with multiple microcomputers makes maximum use of a “Distributed Control System.” Hall indicators, car operating boards, and control panels incorporate high-performance microcomputers. These independent microcomputers analyze elevator operating conditions utilizing self-diagnostic functions and implement immediate control of elevator operations. Also, data transmission buses between microcomputers increase data processing capability.

FLEX-NX series -Elevator Group Supervisory Control System- (GSC)

Fujitec has adopted the “Virtual Passenger Optimization Method” as a new elevator group control system. This system controls elevator group operation by virtually calculating passenger waiting time in advance based on past accumulated data, such as passenger travel patterns and passenger volume at each floor. Also, this method comprehensively calculates passenger waiting time based on extrapolated data of probable future passengers, how many passengers will come to a certain floor when a hall call is registered and/or how many passengers will come to a certain floor when no hall call is registered. This comprehensive analysis reflects whole building traffic conditions for efficient elevator operation control as well as reducing daily passenger waiting time by up to 10 %.

Comparison Simulation with Conventional Group Supervisory Control System

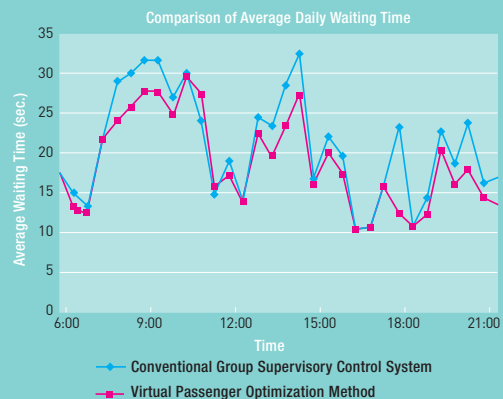

* The graph shows the results of a simulation to reproduce the daily traffic in an actual high-rise condominium having three elevator units and 33 stops.

EZSHUTTLE - Destination Floor Guidance System -

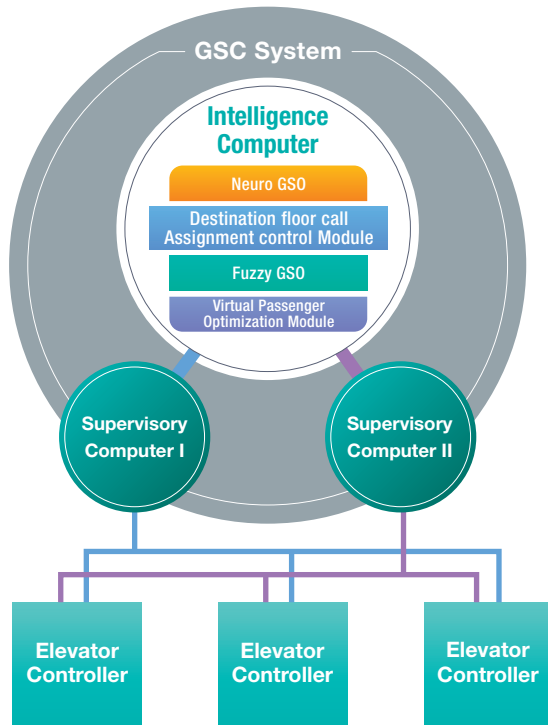

* Based on comparisons of passenger riding time obtained under a conventional elevator operating system and that under a simulated EZSHUTTLE-equipped elevator operating system.

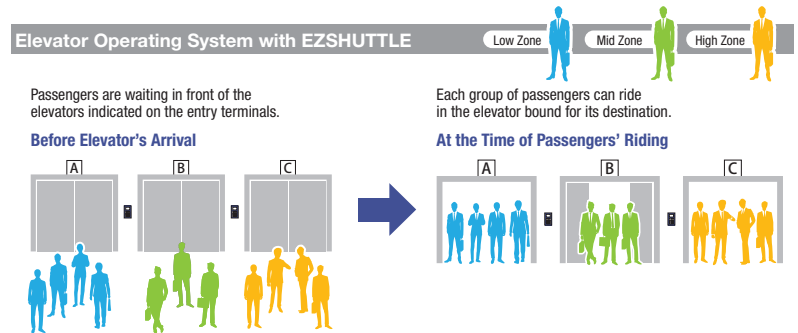

In an elevator operating system with EZSHUTTLE, passengers are required to register their destinations at the elevator floors rather than conventionally registering them inside the elevator. The EZSHUTTLE system then guides passengers to their assigned elevators, which will have been selected to minimize the number of destination stops based on the registered destinations.

This passenger guidance and elevator assignment provides passengers with uncongested elevator service and a reduction in passenger riding time by 50%* at peak travel periods.



Night-Time Self-Checking Operation

- A safety enhancement for increased reliability -

Mechanical brake conditions are automatically checked by moving the elevator during the night time while not receiving any car and hall calls. This night-time self-checking operation increases passenger safety and contributes to a high after-sales product quality.

Multi-Beam Sensor

Multi-beam Sensor emits multiple infrared beams, creating an invisible curtain covering the entire doorway. If any of the beams is interrupted, the closing doors will stop and reopen. This function results in a significantly higher detection rate of a passenger and/or an object in the doorway.



Elevators complying with EN81-20 and EN81-50

The new elevator standards of EN81-20 and EN81-50 have been released by *European Committee for Standardization*, making void the former standards of EN81-1 and EN81-2. The requirements for the production and installation of elevators are stated in EN81-20; the requirements for the inspection and test of their component parts in EN81-50. In response to this release, the specifications of Fujitec elevators have been updated. The following are several main items adopted for the arrangement of elevator specifications.

For Passengers

1 Prevention of the Occurrence of the Ascending Elevator's Overspeed (ACOP: Ascending Car Overspeed Protection)

In order for the ascending elevator not to overspeed, the elevator system is equipped with ascending car overspeed protection means.

2 Protection against an Unintended Movement of Elevator (UCMP: Unintended Car Movement Protection)

Unintended movement of a car is detected by an independent safety-purpose control circuit. This function increases the safety of passengers.

3 Strength of Landings and Car Doors

The strength of landing and car doors is enhanced in order for them to be retained in their given position. The safety of passengers at landing floors and inside car has been increased.

4 Provision of Enough Lighting Intensity inside the Elevator

- a) the lighting intensity of ceiling light 100 lux or more 1 meter above car floor
- b) the lighting intensity of emergency light 5 lux or more 1 meter above car floor (1-hour lighting period is required.)

5 Multi-Beam Sensor on Elevator Door for Passenger Safety

For the enhancement of the safety of passengers entering and leaving from the elevator, multi-beam sensor is provided and installed on car door based on the following.

- a) Multi-beam sensor detects an obstacle of which the diameter is 50 mm or more.
- b) Multi-beam sensor must detect the obstacle within the vertical range from 25 mm to 1600 mm above door sill.
- c) When detecting the obstacle, the closing door must stop and open automatically.

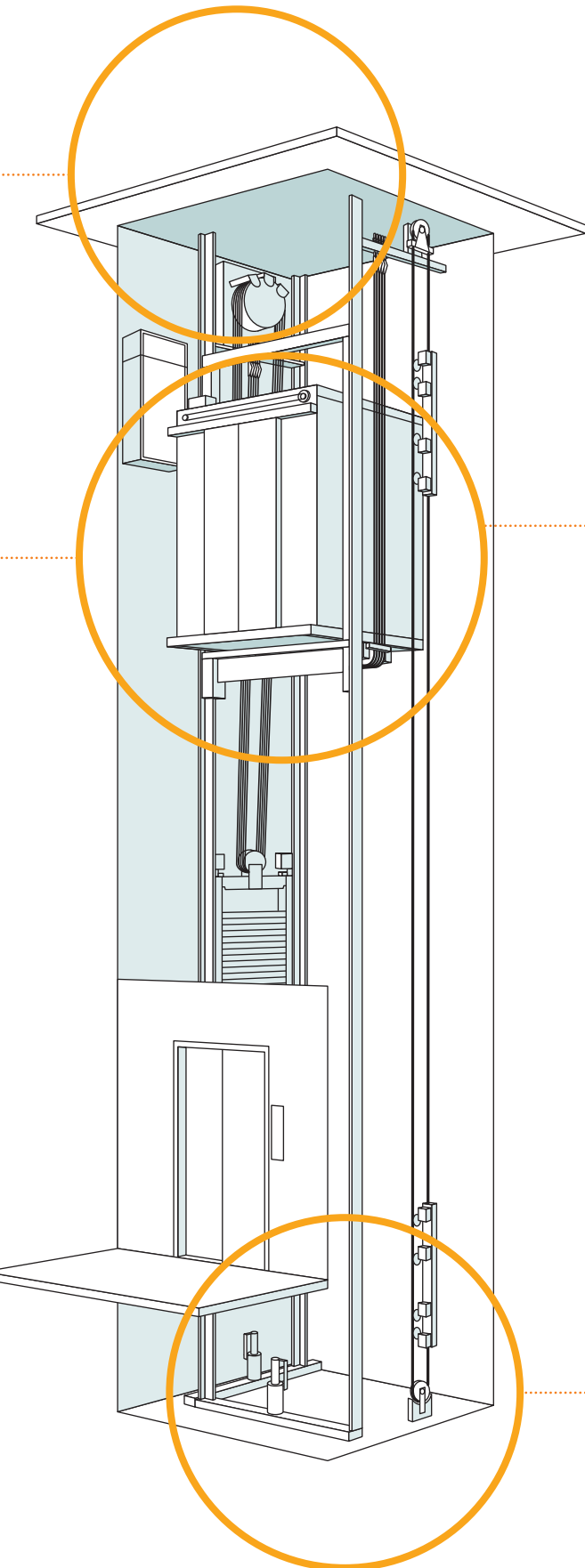

For Maintenance Staff

1 Refuge Space on Car Roof and Clearance in Headroom

The layout of elevator equipment on car roof and overhead space complies with the requirements of EN81-20. Due to this compliance, refuge space is increased for the safety of maintenance staff.

2 Balustrades on Car Roof

The height and strength of the balustrades on the car roof are increased based on the requirements of EN81-20. This increase contributes to the reduction of the risk that a maintenance person falls into the hoistway.

3 Provision of Inspection Control Station in Hoistway Pit

To ensure more safety for the maintenance staff working in the pit, Inspection Control Station is added in the bottom of the hoistway.

4 Refuge Space and Clearance in Hoistway Pit

Layout of elevator equipment in the hoistway pit based on the requirements of EN81-20 creates larger refuge space and ensures more safety for the maintenance staff.

5 Safe Design and Enough Strength of Pit Access Ladder

In order for the maintenance staff to safely enter the hoistway pit, strengthening of a pit access ladder with safe design is required.

No Elevator Machine Room Results in Space Saving

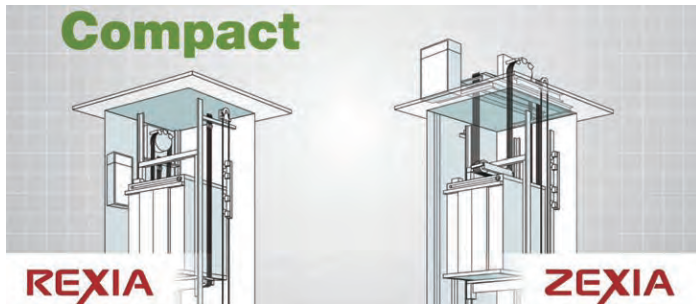

Machine room is no longer required for REXIA. This remarkable feature reduces construction cost, and increases the freedom of layout design in the building.

Gearless Traction Machine with Permanent Magnetic Synchronous Motor

The gearless traction machines with a permanent magnetic synchronous motor assure high riding comfort quality and low power consumption.

This newly adopted technology reduces the weight and size of a traction machine, because gears are no longer required for elevator speed control.

In addition, REXIA's small machines require less motor capacity and power consumption compared to conventional elevators. The differences are shown below.

Given elevator operating conditions:

- 1) The maximum number of elevator operations per day: 600 times
- 2) The travel distance in a single operation: 30 meters
- 3) The rated speed: 1.0 meter per second
- 4) The rated load: 1200 kgs.

Required Motor Capacity

REXIA Elevator (PMGL)	8 kW
Conventional Elevator (ACGD)	11 kW



Energy-efficient Traction Machines reduce power consumption and CO₂ emission.

LED Lights on Car Ceiling

Fujitec’s adoption of energy-efficient, long-lasting LED downlights for car ceiling light saves energy, and leads to the preservation of environment.



	Filament Light Bulb	LED Light Bulb	Improvement Results
Lifetime	approx. 1,500 hours	approx. 20,000 hours	approx. 13 times
Wattage	90 W	9 W	1/10 (one-tenth)

Electric Power Regenerative Unit

The adoption of electric power regenerative unit instead of conventional heat dissipation resistor allows the traction-machine-produced electricity to be fed back to the building’s electrical facilities. The amount of electricity fed back to the facilities is equivalent to nearly 35 % * of the whole amount of electricity consumed by the corresponding type of elevator with heat dissipation resistor.

*: The value of this percentage differs based on the specifications of the elevator and its usage.

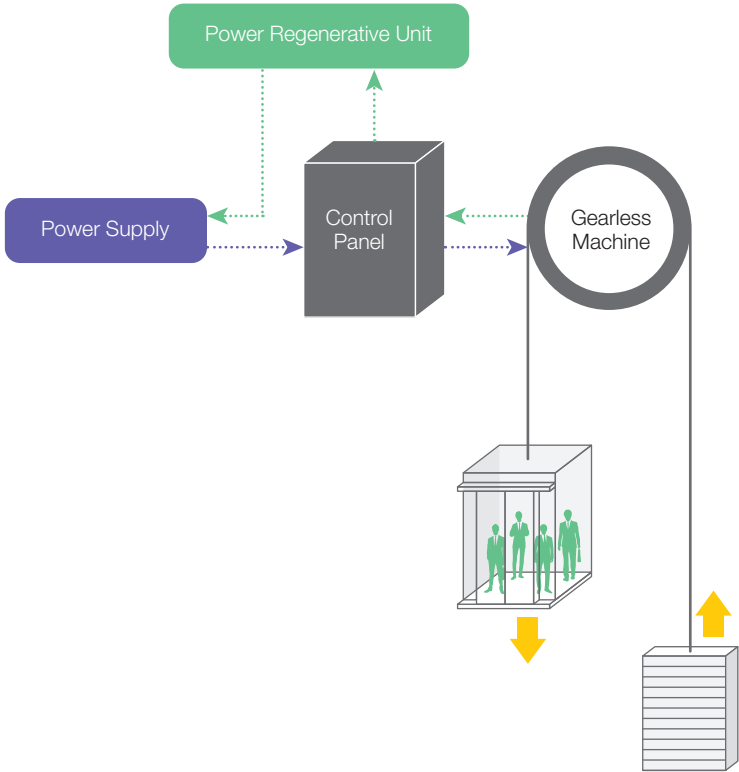

COMFORT DESIGN

The latest human engineering technologies are reflected on the REXIA elevators. As the function of man-machine interface, tactile characters and letters are adopted for the buttons on the elevator operating boards and the elevator call buttons in the hall fixtures. Also, the devices and functional systems for the creation of comfort for the elevator passengers are equipped in the elevator.



Tactile Letters and Characters for Operating Buttons

Standard

Tactile letters and characters are adopted for the elevator operating buttons. They are raised from the surface of the buttons in order for a passenger to recognize the assigned function for each button. Their unique design functions as a friendly interface between the passengers and the elevators.



IONFUL

(Plasmacluster™* ION Generating Device)

Optional

The first elevator company that installed a Plasmacluster Ion generating device in an elevator is Fujitec. The device built in an elevator’s ventilation unit disinfects airborne mold, bacteria, viruses, allergens, and odor molecules as well as creating clean air in the elevator. This increases the comfort of passengers.

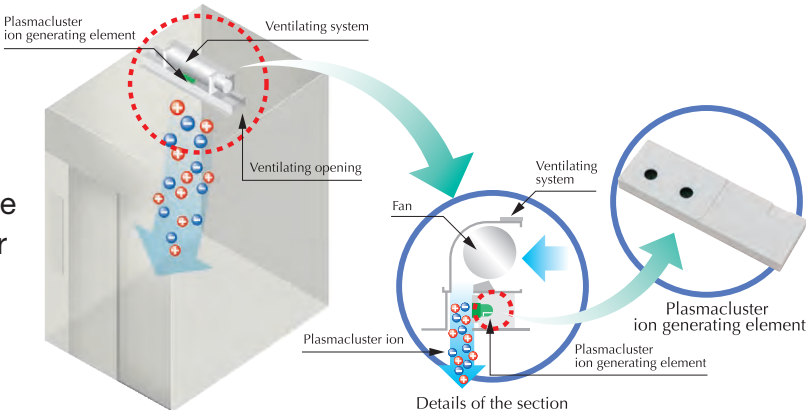

*Plasmacluster is a trademark of Sharp Corporation.

VONIC

(Automatic Voice Announcement System)

Optional

A computerized voice system provides passengers with timely information about car directions, car arrivals, door opening and closing, and emergencies, etc. (Voice announcement is made in English. At the customer’s request, it may be made in another language.)



CAR DESIGN

Standard Car Design



Car Ceiling: CT-GS01: (Ceiling with LED Downlights)	Panel: Steel Sheet with Paint Finish Color in the image: white (5AABJ001) The other two standard colors are available.
Car Panel, Car Transom, Return Panel, Car Door	Steel Sheet with Paint Finish Color in the image: light green (5AABJ008) The other seven standard colors are available.
Car Floor: PVC Tiles with 2-mm Thickness	PVC Tiles Color in the image: white (L51) The other five standard PVC tiles are available.
Car Sill	Extruded Aluminum
Car Operating Board	Type: COB-GS01 Stainless Steel with Hairline Finish

Color Variation

For Car Ceiling

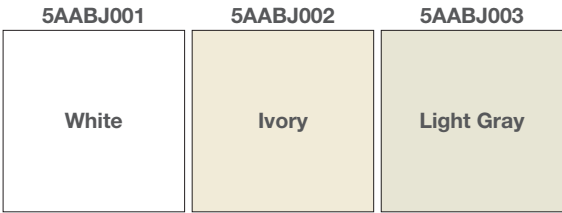

For Car Panel



(Light Green: 5AABJ008)



(Ivory: 5AABJ004)

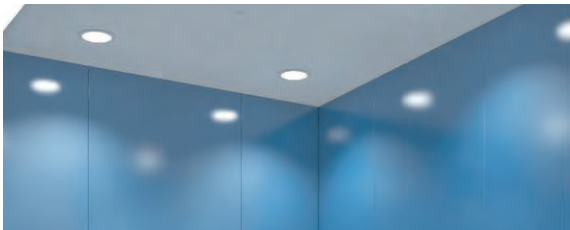

(Ocean Blue: 5AABJ009)

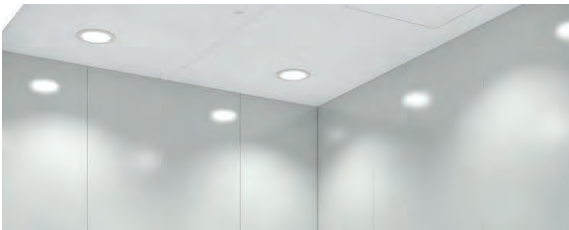

(Light Gray: 5AABJ005)



(Silver: 5AABJ010)

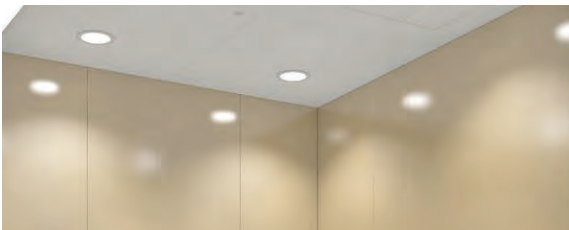

(Beige: 5AABJ006)

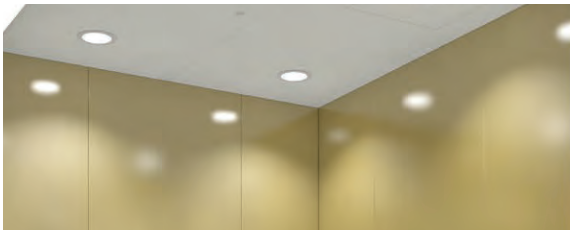

(Gold: 5AABJ011)

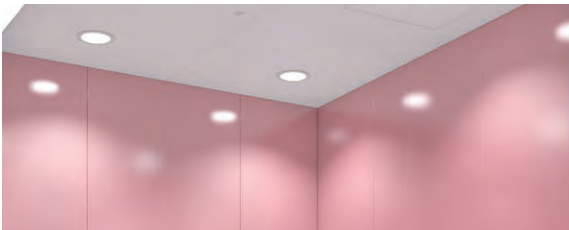

(Sakura: 5AABJ007)

For Car Floor

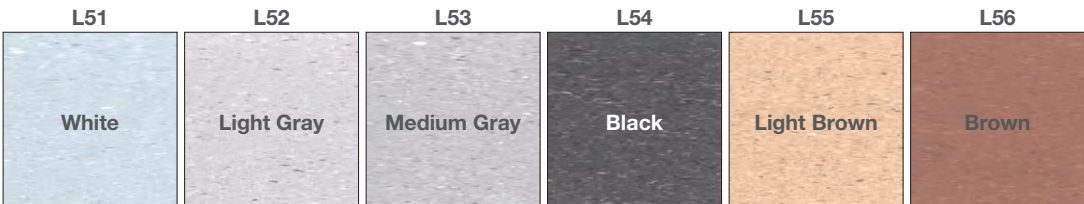

* Actual colors may differ from the image.

CAR DESIGN

Design 1



Car Ceiling	CT-GS01 Ceiling with LED downlights
Car Panel	Steel Sheet with Paint Finish Color: Light Gray (5AABJ003)
Return Panel	Stainless Steel with Hairline Finish
Car Transom	Stainless Steel with Hairline Finish
Car Door	Stainless Steel with Hairline Finish
Car Floor	PVC Tiles with 2-mm Thickness Color in the image: Light Gray (L52)
Car Sill	Extruded Aluminum
Car Operating Board	COB-GS02 Stainless Steel with Hairline Finish
Ventilation Fan	With Two Air vents

Design 2



Car Ceiling	CT-GC03 Ceiling with indirect lighting LED downlights
Car Panel	Steel Sheet with Paint Finish Color: Ivory (5AABJ002)
Return Panel	Steel Sheet with Paint Finish Color: Gold (5AABJ011)
Car Transom	Stainless Steel with Hairline Finish
Car Door	Stainless Steel with Hairline Finish
Car Floor	PVC Tiles with 2-mm Thickness Color: Brown (L56)
Car Sill	Extruded Aluminum
Car Operating Board	COB-GS01 Stainless Steel with Hairline Finish
Handrail	Side: Stainless Steel with Hairline Titanium-Gold-Finished (CPH-GC04) Rear: Stainless Steel with Hairline Finish (CPH-GC01)

CAR DESIGN

Design 3

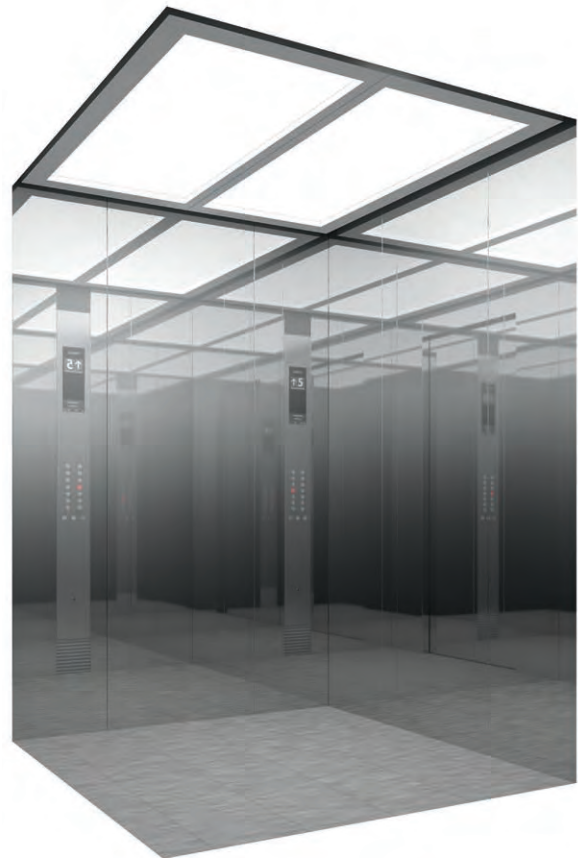

Car Ceiling	CT-GC02 Ceiling with indirect lighting LED tubes
Car Panel	Steel Sheet with Paint Finish Color: Light Gray (5AABJ003)
Return Panel	Stainless Steel with Mirror Finish
Car Transom	Stainless Steel with Mirror Finish
Car Door	Stainless Steel with Mirror Finish
Car Floor	PVC Tiles with 2-mm Thickness Color: Light Gray (L52)
Car Sill	Extruded Aluminum
Car Operating Board	COB-GC01 Stainless Steel with Hairline Finish

Design 4



Car Ceiling	CT-GC02 Ceiling with indirect lighting LED tubes Steel Sheet with Paint Finish Color: White (5AABJ001)
Car Panel	Stainless Steel with Etching Finish Pattern: PH-103C
Return Panel	Stainless Steel with Hairline Finish
Car Transom	Stainless Steel with Hairline Finish
Car Door	Stainless Steel with Etching Finish Pattern: PH-103C
Car Floor	PVC Tiles with 2-mm Thickness Color: Medium Gray (L53)
Car Sill	Extruded Aluminum
Car Operating Board	COB-GC02 Stainless Steel with Hairline Finish
Mirror	Upper-side Full-width Mirror

CAR DESIGN

Design 5



Car Ceiling	CT-GC01 Ceiling with indirect lighting LED lamps
Car Panel	Steel Sheet with Paint Finish Color: Ivory (5AABJ002)
Return Panel	Steel Sheet with Paint Finish Color: Ivory (5AABJ004)
Car Transom	Steel Sheet with Paint Finish Ocean Blue (5AABJ009)
Car Door	Steel Sheet with Paint Finish Ocean Blue (5AABJ009)
Car Floor	PVC Tiles with 2-mm Thickness Color: Black (L54)
Car Sill	Extruded Aluminum
Car Operating Board	COB-GC01 Stainless Steel with Hairline Finish

Design 6



Car Ceiling	CT-GC01 with ventilation fans, Ceiling with indirect lighting LED lamps Steel Sheet with Paint Finish, Color: White (5AABJ001)
Car Panel	Side Panels: Stainless Steel with Etching Finish Pattern: PH-313 at the Center: Full-Height Mirrored Stainless Steel Rear Panels: at the Sides: Stainless Steel with Etching Finish Pattern: PH-313
Return Panel	Stainless Steel with Hairline Finish
Car Transom	Stainless Steel with Hairline Finish
Car Door	Stainless Steel with Etching Finish, Pattern: PH-313
Car Floor	PVC Tiles with 2-mm Thickness, Color: Light Brown (L55)
Car Sill	Extruded Aluminum
Car Operating Board	COB-GC02, Stainless Steel with Hairline Finish
Handrail	Stainless Steel Plate with Hairline Finish (CPH-GC02)
Mirror	Full-Height Mirror Panel flush with Car Panel

COLOR AND PATTERN VARIATIONS

For Car Ceiling; Paint Finish (Flat finish)

5AABJ001

5AABJ002

5AABJ003

White

Ivory

Light Gray

For Car Panel, car Door, Landing Door and Landing Transom; Etching Patterns

PH-103C

PH-112B

PH-113A

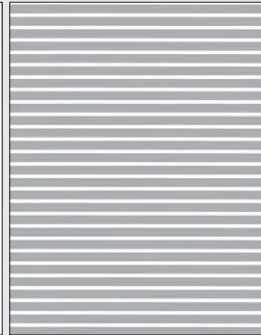

PH-206

PH-130

PH-313

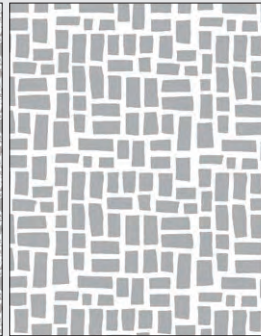

PH-649

PH-703

PH-801

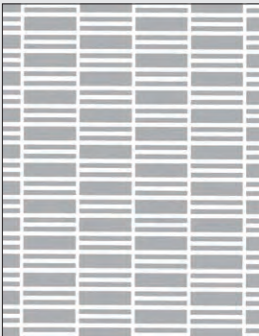

**For Car Panel, Return Panel, Car Door, Car Transom,
Jamb, Landing Door and Landing Transom;
Paint Finish (Semi-gloss finish)**

5AABJ004	5AABJ005	5AABJ006	5AABJ007	5AABJ008	5AABJ009	5AABJ010	5AABJ011
Ivory	Light Gray	Beige	Sakura	Light Green	Ocean Blue	Silver	Gold

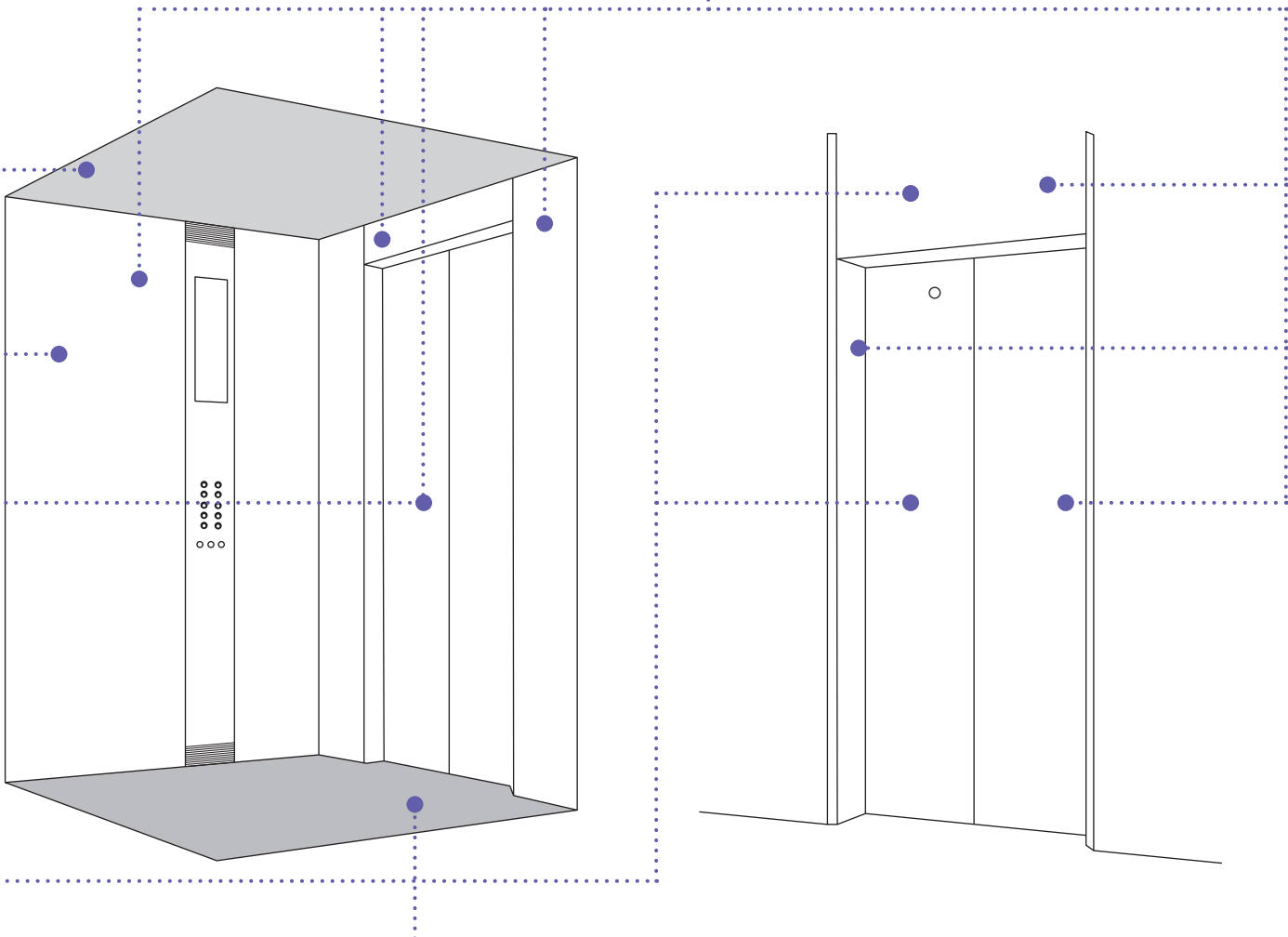

**For Car Floor;
PVC Tiles (2-mm Thickness)**

L51	L52	L53	L54	L55	L56
White	Light Gray	Medium Gray	Black	Light Brown	Brown

Note:
(1) Actual colors may differ from the image. (2) The dimensions of an actual pattern differ from the image. (3) The scale of an actual design differs from the image.

CEILING DESIGN

Standard

Optional

CT-GS01

*1

Lighting: LED Downlights
Panel: Paint Finish

Emergency Exit^{*3}

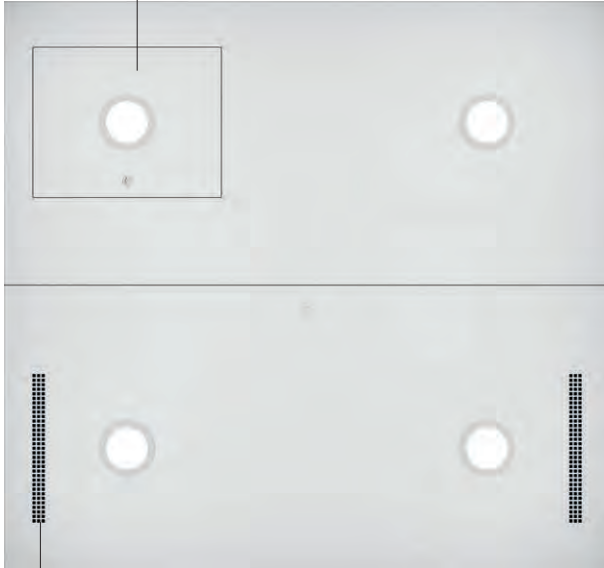

Air vent^{*4}

CT-GC02

*2, *5

Lighting: Indirect Lighting LED tubes
Panel: Paint Finish

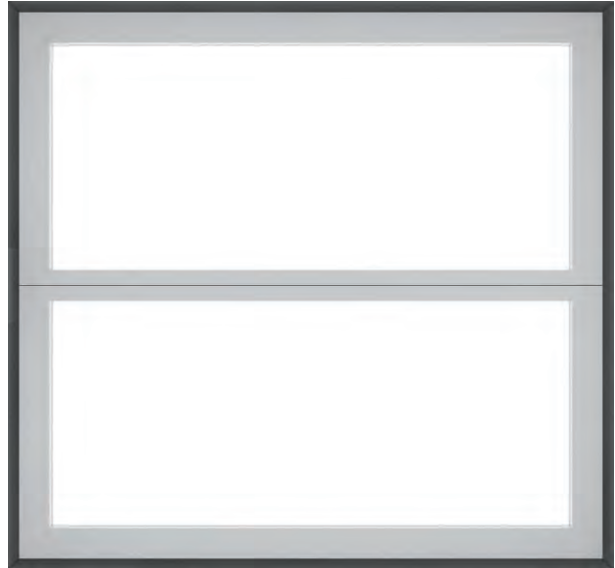

CT-GC01

*1

Lighting: Indirect Lighting LED Lamps
Panel: Paint Finish

Emergency Exit^{*3}

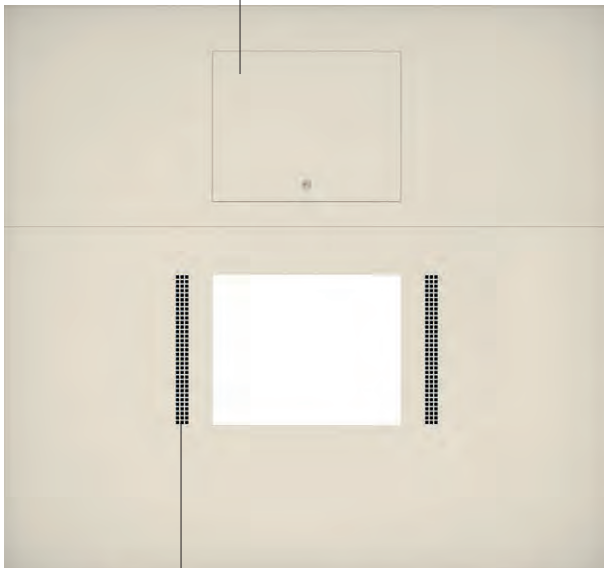

Air vent^{*4}

CT-GC03

*2

Lighting: Indirect Lighting LED Downlights
Panel: Paint Finish

Emergency Exit^{*3}

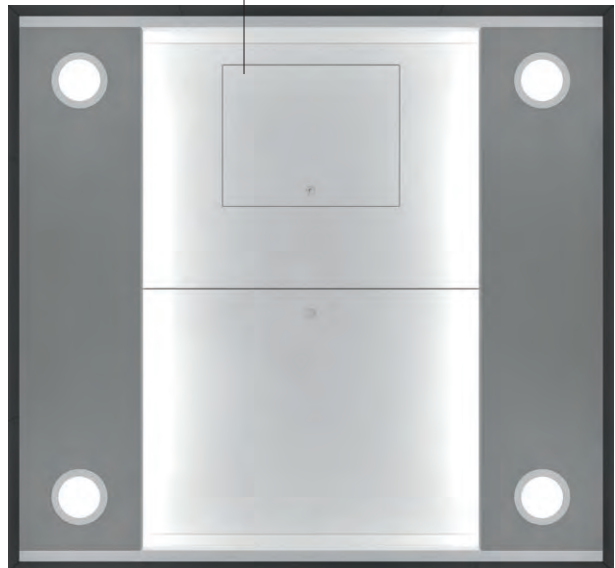

Note:

*1. Clear Ceiling Height: 2350mm, Top Ceiling Height: 2350mm

*2. Clear Ceiling Height: 2250mm, Top Ceiling Height: 2400mm

*3. Emergency exit (Required). Applicable for the above ceiling designs.

*4. Two Air vents added when Car Ventilation Fan is applied (Optional Specification)

*5. When the car interior width is greater than 1650mm, the acrylic ceiling will be divided into four sheets instead of two.

Handrail

Stainless Steel with Hairline Finish

CPH-GS01



Pipe Handrail with curved ends

CPH-GC01



Pipe Handrail with straight ends

CPH-GC02



Flat-plate Handrail with curved ends

CPH-GC03



Titanium-Gold-Finished Pipe Handrail with curved ends

CPH-GC04



Titanium-Gold-Finished Pipe Handrail with straight ends

CPH-GC05

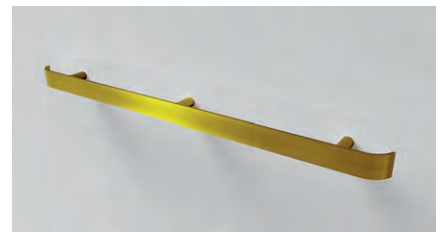

Titanium-Gold-Finished Flat-plate Handrail with curved ends

Mirror



Standard Wall-Mounted Mirror



Upper-side Full-width Mirror



Full-height Mirror Panel flush with Car Panel

Note: Material for mirror panel is required to be confirmed.

ENTRANCE DESIGN



Standard

Entrance with Narrow Jambs

Landing Door	Steel Sheet with Paint Finish Color: Sakura (5AABJ007)	
Jamb	Steel Sheet with Paint Finish Color: Sakura (5AABJ007)	
Sill	Extruded Aluminum	
Hall Indicator with Hall Buttons (IN-GS01)	Vertical Indicator	Orange Dot-Matrix LEDs
	Faceplate	Stainless Steel with Hairline Finish
Emergency Operation Panel (EOP)	Installed at Top floor	
	Faceplate	Stainless Steel with Hairline Finish



Optional

Entrance with Wide Jambs

Landing Door	Stainless Steel with Hairline Finish	
Jamb	Stainless Steel with Hairline Finish	
Sill	Extruded Aluminum	
Hall Lantern (HLL-GS01)	Round Jewel Mounted Hairline-Surface Stainless Steel with Inclined Rims at its Bottom	
Hall Buttons (HB-GS01)	Tactile Button Incorporated Hairline-Surface Stainless Steel with Inclined Rims at its Top	
Emergency Operation Panel (EOP)	Installed at Top floor	
	Faceplate	Stainless Steel with Hairline Finish



Optional

Entrance with Wide Jambs and Transom

Landing Door	Stainless Steel with Etching Finish Pattern: PH-112B	
Jamb	Stainless Steel with Hairline Finish	
Sill	Extruded Aluminum	
Hall Indicator (IN-GS01)	Horizontal Indicator	Orange Dot-Matrix LEDs
Hall Buttons (HB-GS01)	Tactile Button Incorporated Hairline-Surface Stainless Steel with Inclined Rims at its Top	
Emergency Operation Panel (EOP)	Installed at Top floor	
	Faceplate	Stainless Steel with Hairline Finish

Required Heights for Landing Fixtures

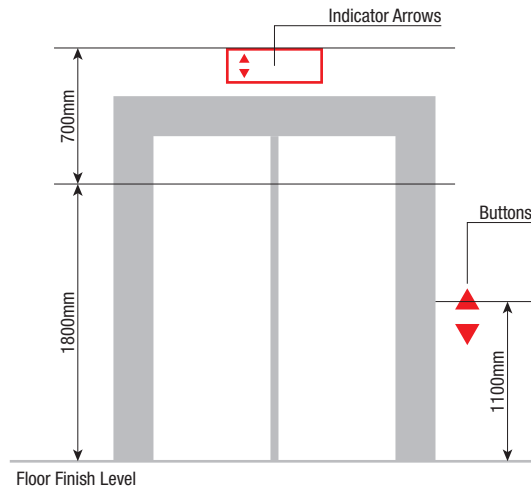

1. The indicator arrows are required to be positioned between 1800mm and 2500mm from the floor level.
2. Maximum height between the floor level and the centerline of the highest button is 1100mm.

Minimum Car Size and Recommended Entrance Width:



1. For TYPE 1, the required minimum width of entrance is 800 mm.
2. For TYPE 2, 900-mm width is recommended for the entrance.
3. For TYPE 3, 1100-mm width is recommended for the entrance.

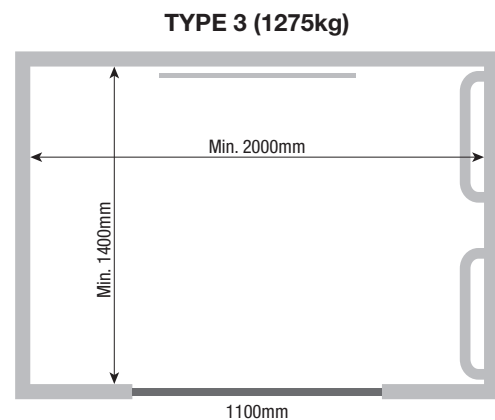
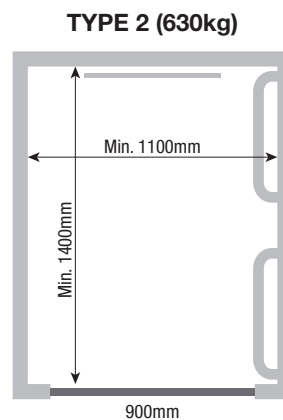
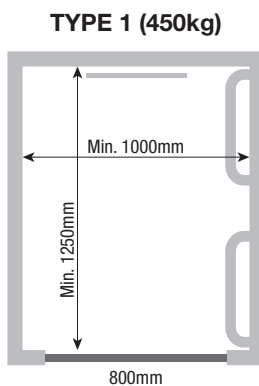

CAR OPERATING BOARDS

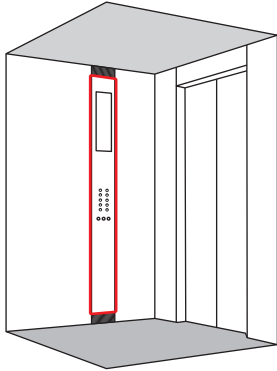

Faceplate: Stainless Steel with Hairline Finish
 Indicator: Orange Dot-Matrix LED or LCD

Standard

Optional

Standard Types

Optional Types

COB-GS01

COB-GS02

COB-GC01

COB-GC02



With standard car call buttons

With ten-key car call buttons

With standard car call buttons

With ten-key car call buttons

Car Position Indicator

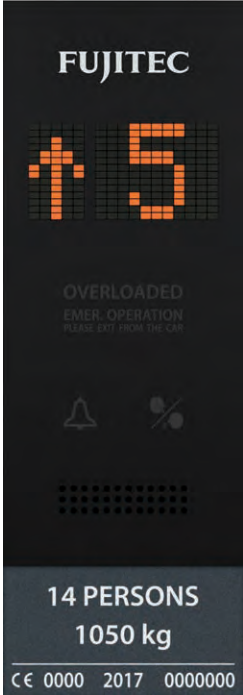

Indication by LEDs

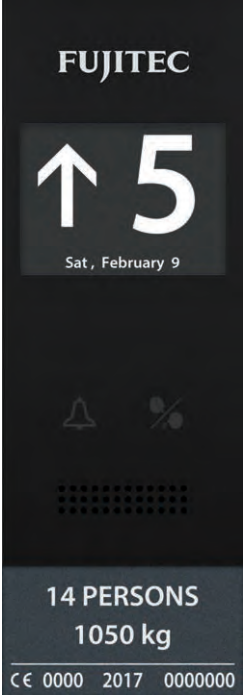

Indication on LCD

Destination Floor Indicator

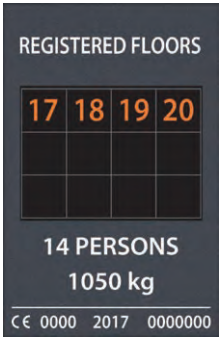

Button

Tactile



Button Head: Stainless Steel with Bead Blast Finish

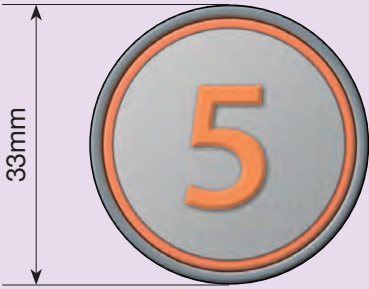

Color of Illumination: Amber

- Note:
1. Car Operating Boards satisfy the requirements of EN81-70.
 2. Some floor names and alphabet letters are not applicable for the indication of a destination floor.
 3. The incorporation of key switch on the Car Operating board (COB) is Optional.
 4. For Center-opening doors; when entering the car; Car Operating Board on the right hand side
 5. For Side-opening doors; Car Operating Board on the closing jamb side.

HALL FIXTURES

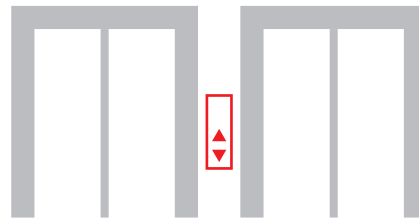
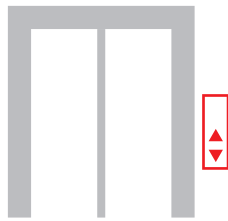

Standard

Optional

Hall Indicator with Hall Buttons

Faceplate	Stainless Steel with Hairline Finish
Indicator	Orange Dot-Matrix LEDs
Button	Tactile Type

Standard Hall Indicator with Hall Buttons



IN-GS01

*2,*3,*4,*5

Elevator Operation	Simplex Operation
Faceplate Design	With Inclined Rim at Top End



IN-GS02

*2,*3,*4,*5

Elevator Operation	Duplex Operation
Faceplate Design	With Inclined Rim at Top End

Optional Hall Indicator with Hall Buttons



IN-GC01

*2,*3,*4

Elevator Operation	Simplex Operation
Faceplate Design	Without Inclined Rim



IN-GC02

*2,*3,*4

Elevator Operation	Duplex Operation
Faceplate Design	Without Inclined Rim

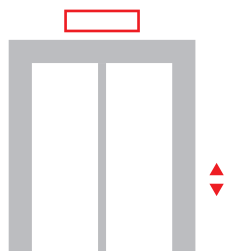

Hall indicator

Faceplate	Stainless Steel with Hairline Finish
-----------	--------------------------------------



HIN-GS01 *1,*3

Elevator Operation	Simplex Operation, Duplex Operation, and Group Operation
Faceplate Design	With Inclined Rim at Side Ends



HIN-GC01 *1,*3

Elevator Operation	Simplex Operation, Duplex Operation, and Group Operation
Faceplate Design	Without Inclined Rim

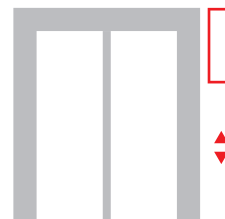

Hall Lantern

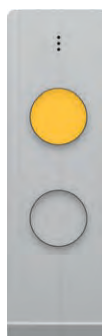

HLL-GS01

Elevator Operation	Simplex Operation, Duplex Operation, and Group Operation
Faceplate Design	With Inclined Rim at Bottom End



HLL-GC01

Elevator Operation	Simplex Operation, Duplex Operation, and Group Operation
Faceplate Design	Without Inclined Rim

Hall Button Unit

Faceplate	Stainless Steel with Hairline Finish
Button	Tactile Type



HB-GS01 *1,*4

Faceplate Design	With Inclined Rim at Top End
------------------	------------------------------



HB-GC01 *1,*4

Faceplate Design	Without Inclined Rim
------------------	----------------------

Note:

- *1. The requirements by EN81-70 are satisfied.
- *2. The requirements by EN81-70 are not satisfied.
- *3. Some floor names and alphabet letters are not applicable.

- *4. The incorporation of key-switch is Optional
- *5. The hall fixtures at the bottom floor have a box behind its faceplate.

SPECIFICATION DETAILS

REXIA[®]

Main Specifications

Capacity

450, 630, 800, 1000, 1200, 1275,
1350, 1600, and 2000 kg

Speed

1.0, 1.5, 1.75, 2.0, 2.5, mps
Application of 2.5 mps is
subject to the satisfaction of the
Standard Dimensions table.

Number of Served Floors

40 Stops or Less

Travel Height

90 m or less

Control Method

VVVF controlled by distributed
32-bit Microcomputers.

Traction Machine

Gearless Machine with Permanent
Magnetic Synchronous Motor

Types of Elevator Operation

1-Car or 2-Car Selective Collective
Operation or Group Control Operation
for 3 to 8 Cars in a Bank

Door Operation System

Permanent Magnetic Motor
controlled by VVVF

Door Opening Type

2-Panel Center Opening
(The elevators of 450-kg load capacity are equipped
with 2-panel side opening doors as standard.)

1. Elevator Operation Control System

Control Systems	Details of the Systems
For One Elevator: 1-Car Selective Collective Operation (: Simplex Collective Operation)	Landing calls in the direction in which the elevator is traveling are served sequentially. After all the landing calls are served, landing calls in the opposite direction will be served. When there are no incoming calls, the elevator stops and stays at the last served floor.
For Two Elevators in a Bank: 2-Car Selective Collective Operation (: Duplex Collective Operation)	Two selective-collective-operation elevators work together in one group. Landing calls are served by either elevator that can respond first. When there are no calls, one will be on standby at the main floor; the other will stay at the last served floor.
For Two to Eight Elevators in a Bank: Group Control Operation For 2 to 8 Elevator in a bank	The operation of more than two elevators in a bank is controlled by a group supervisory system which calculates passenger waiting time in advance based on the accumulated traffic data, such as passenger travel patterns and passenger volume at each floor, etc.

2. Functions and Specific-Purpose Operations, etc.

Functions and Specific-Purpose Operations, etc.		Details	●: Standard / ■: Optional	
Passenger-Safety Functions	Alarm Buzzer	When the emergency button is pressed, the car-top-mounted buzzer will sound an alarm.	●	
	Rescue Operation to Nearest Floor	In the event that an elevator stops between floors, a safety circuit will automatically analyze the situation and slowly move the elevator to the nearest available floor.	●	
	Automatic Releveling	In the event that an elevator floor isn't leveled with the landing floor, the Automatic Releveling function will initiate and make the elevator floor flush with the landing floor.	●	
	Emergency Car Lighting	In the event of a power failure, a self-charging-battery-equipped emergency lighting system will light up the elevator for passenger safety and relief.	●	
	Intercom System (2 way Communication System)	An intercom for 2-way communication is installed in the elevator. It allows 4 remote telephones to communicate with the elevator; one on the car top, one in the pit, one at the top floor entrance and one in the building-system control room.	●	
	Multi-Beam Sensor	Multi-beam Sensor emits multiple infrared beams, creating an invisible curtain covering the entire doorway. If any of the beams is interrupted, the closing doors will stop and reopen.	●	
	Multi-Beam Sensor with Mechanical Safety Edge	A multiple-beam sensor can be incorporated in mechanical safety edges of elevator doors.		■
	Night-Time Self-Checking Operation	During the night time when the elevator doesn't receive any car and hall calls, the system will move the elevator and check the mechanical brake conditions automatically.	●	
	Open Door Warning	If a passenger tries to forcibly open the doors while the elevator is in operation, the warning device will sound an alarm.	●	
	Unintended Car Movement Protection (UCMP)	The Unintended Car Movement Protection system prevents elevator movement from the landing floor, while passengers are entering and getting off the elevator.	●	

SPECIFICATION DETAILS

Functions and Specific-Purpose Operations, etc.	Details	● : Standard / ■ : Optional		
Efficient-Operation Functions	Anti-Nuisance Function	<p>1) For elevators with three or more landings, when three or more car calls are registered at the same time, or when four or more car calls are registered in an extremely short period of time, the system will automatically cancel the activated car calls.</p> <p>2) For elevators with five or more landings, when an elevator loaded with 100 kg or less receives four or more car call registrations, the system will cancel all the activated registrations.</p>	●	
	Auto Adjustment of Door Open Time	This function automatically adjusts the door-hold open time (dwell time) at each floor depending on passengers' hall- and car- call registration situations.	●	
	Automatic Return to Main Floor (for Group Control Operation)	When an elevator does not receive any car- or hall- calls for a certain period of time, the Automatic Return to Main Floor function makes the elevator go to the lobby or a predetermined floor and waits in standby for passengers to board.	●	
	Door Nudging	If the car doors are held open over a given period of time, the Door Nudging function will close them slowly with an audible alarm.	●	
	Auto-Separation after Elevator Failure (for Group Control Operation)	When an elevator under group control operation fails to operate normally, it will be separated from the elevator group so as not to affect the overall group elevator performance.	●	
	Load Bypass	<p>When a traveling car is fully loaded, it will bypass floors where hall calls are registered. Those hall calls will be assigned to another available elevator.</p> <p>*For Group Control Operation, Load Bypass is originally furnished</p>		■ *
	Overload Warning	When a car becomes overloaded, the warning alarm will sound. The elevator doors will not close until the overloaded state is resolved.	●	
	Reverse-Direction Car-Call Cancellation	In the event that a passenger tries to register a car call that is behind the car's current travelling direction, the elevator system will regard it as a nuisance call and ignore it in order to maintain the elevator service efficiency.	●	
	Wrong Car-Call Register Cancellation	In case a passenger presses the wrong car call button, this mistake can be cancelled by pushing the same button twice.	●	

Functions and Specific-Purpose Operations, etc.		Details	● : Standard / ■ : Optional	
Passenger-Comfort Functions	Arrival Chime(In Car)	When a car arrives at a destination floor, an arrival chime will sound softly.		■
	Attendant Operation	By using attendant-operation buttons inside a car operating board's cabinet, authorized personnel can register car calls for in-car passengers. In addition to monitoring incoming hall calls, the attendant decides the car travel direction and operates the car doors with priority service for in-car passengers.		■
	Automatic Voice Announcement System (VONIC) in English	A computerized voice system provides passengers with timely information about car directions, car arrivals, door opening and closing, and emergencies, etc. At the customer's request, announcements in other languages can be added.		■
	Car Ventilation Fan	Ventilation inside car, fan attached to the ceiling to keep car ventilated well.		■
	Plasmacluster™ Ion Generating Device (IONFUL)	The first elevator company that installed a Plasmacluster Ion generating device in an elevator is Fujitec. The device built in an elevator's ventilation unit disinfects airborne mold, bacteria, viruses, allergens, and odor molecules as well as creating clean air in the elevator. This increases the comfort of passengers. *: Plasmacluster is a trademark of Sharp Corporation.		■
	Visual Display on Car Operating Board	Informing on an elevator's current condition, a visual display on the car operating board will provide passengers with timely text messages such as "OVERLOADED", "EMER. OPERATION, PLEASE EXIT FROM THE CAR." etc,	●	
	Visual Display on Landing Fixture	Informing on an elevator's current condition, a visual display on the landing fixture will provide waiting passengers with timely text messages such as "OVERLOADED", "EMER. OPERATION", etc.		■
Energy-Saving Functions	Automatic Light Control	If an elevator receives no car- and hall- calls within a certain period of time, its lights will turn off automatically.	●	
	Automatic Fan Control	If an elevator receives no car- and hall- calls within a certain period of time, its ventilation fan will turn off automatically.		■
	Elevator Operation Period Control	The elevator operation period in a day is automatically controlled by a timer mounted on the control panel's computer board.		■
	Parking Operation	When an elevator is shifted to Parking Operation mode, the elevator will move to the pre-assigned floor and park with its doors closed, and car lights and fan turned off.		■
	Electric Power Regenerative Unit	The adoption of electric power regenerative unit instead of conventional heat dissipation resistor allows the traction-machine-produced electricity to be fed back to the building's electrical facilities.		■

SPECIFICATION DETAILS

Functions and Specific-Purpose Operations, etc.		Details	● : Standard / ■ : Optional	
Specific-Purpose Operations	Battery-Powered Automatic Landing Operation (LANDIC)	In the event of a power failure, a compact battery power source will move the car to the nearest available floor.		■
	Door Opening Failure Rescue Operation	When an elevator fails to open the doors at a landing floor, it will move to the next available floor and open them.	●	
	Earthquake Rescue Operation (WAVIC)	When a seismic sensor has detected a seismic wave (the secondary seismic wave), the elevator(s) will be shifted to rescue operation mode and automatically move to the nearest available floor for passenger evacuation.		■
	Fire Operation	In the event of a fire, the Fire Operation mode will automatically take an elevator directly to an evacuation floor and immobilize it there.		■
	Firefighter Operation	The Firefighter Operation mode allows firefighters to use an elevator during a fire. Under this mode, the elevator responds only to car call registrations made by firefighters.		■
	Independent Operation	When Independent Operation is turned on, a designated elevator can operate independently for exclusive use.		■
	Standby Power Operation	In the event of a power failure, the elevator(s) will return to an evacuation floor using standby power and will be held there on standby. Note: Standby power system shall be provided and installed by third parties.		■
Equipment for Building Security, etc.	Building-Management-System (BMS) Interface	Through a purpose-built interface, a building management system can receive up-to-date elevator operation data.		■
	CCTV-Camera Cables (between car and elevator control panel)	For a CCTV camera, video-signal cables between the hoistway and control panel are available.		■
	Elevator Operation Supervisory Panel (such as watching board, console panel, etc.)	Through an elevator operation supervisory panel, the statuses of elevator operation can be monitored and the elevator operation controlled.		■
	Elevator Visual Monitoring System (ELVIC)	By monitoring the current statuses of running elevators and giving necessary commands to elevators through desk-top PCs in a specific remote location, ELVIC manages and controls elevator operation. (Desk-top PCs shall be provided by the customer.)		■
	In-Car Power Receptacle	A power receptacle can be installed in an elevator. (Maximum allowable wattage: 1 kW)		■

1. Elevator Hoistway Environment

Hoistway Temperature	Hoistway temperature shall be kept from 5 °C (41 °F) to 40 °C (104 °F).
Relative Humidity	<ol style="list-style-type: none"> When a temperature reaches at 40 °C (104 °F), the relative humidity does not go beyond 50%. In the year's most humid month(s), relative humidity shall be kept lower than 90 % and the temperature lower than 25°C (77 °F). Dew condensation prevention measures shall be taken, if there are the possibilities that condensation form inside and on electrical equipment.

2. Electric Power Source

Type of Power Supply	<ol style="list-style-type: none"> Three-Phase Power Supply for Elevator Driving Machine Single-Phase Power Supply for Lighting Equipment
Allowable Error of Voltage Value	The allowable error of voltage value is 7 % above and below the rated voltage.

3. Acceptable Inclination of Hoistway's Vertical Centerline

Hoistway's Vertical Length	Centerline's Tilt away from the Plumb Line (unit: mm)
30 meter or less	0 to 25 mm or less (Hoistway tolerance: 0 to 25mm or less on one side, 0 to 25mm or less in total)
more than 30 m up to 60 m or less	0 to 35 mm or less (Hoistway tolerance: 0 to 25mm or less on one side, 0 to 35mm or less in total)
more than 60 m	0 to 50 mm or less (Hoistway tolerance: 0 to 25mm or less on one side, 0 to 50mm or less in total)

4. Work done by Others

The following items are in the scope of other contractors' work, not covering all items done by them.

For Hoistway

1.	Construct solid-state, fire-proof elevator hoistway.
2.	Cut out landing walls for Fujitec's installation of elevator operating fixtures and elevator equipment.
3.	Do wall finishing work by filling cement between jambs and landing walls.
4.	Do wall finishing work by filling cement between landing fixtures and landing walls.
5.	Give water-proofing and drainage treatment in elevator pit including the installation of pumping equipment.
6.	Install space divider screens between respective elevators in a hoistway pit.
7.	Install steel separator beams at regular vertical intervals in a hoistway.
8.	When hoistway is constructed with bricks, put steel lintels in its walls for Fujitec's installation of rail brackets. The steel lintels must be completely fixed inside the walls. The vertical height of the lintel is required to be 300 mm or more. For details, see the relevant drawings.
9.	When an elevator traveling distance from a floor to the next is more than 11 m, make an opening on the hoistway wall between the floors and install emergency exit doors in the opening for passenger evacuation.
10.	It is advised that there is no human access to the space below the hoistway pit.
11.	When the bottom of a hoistway pit is deeper than the required level, add backfill concrete up to the required level.
12.	Provide and install a pit ladder based on the layout drawings.
13.	Provide and install a power switching / distributing board in the hoistway.
14.	Provide and install electrical pipes, wires, and leads in the hoistway. They shall be extended from the power switching / distributing board to the controller, machine, and their related apparatuses.
15.	Provide and install all of electricity supply apparatuses (inclusive of pipes, leads, wires, etc.) on various routes from the building's electricity supply system to the hoistway, landing floors and Fujitec-designated locations.
16.	Install air ventilator(s) and/or air conditioner(s) in order to keep the hoistway temperature between 5 °C (41 °F) and 40 °C (104 °F).
17.	Provide and install electrical outlets inside the hoistway.
18.	Install lighting equipment of 30 watt or more at 7-meter intervals inside the hoistway with 0.5-meter clearance at the top and bottom of the hoistway. The lighting intensity is required to be 50 lux or more at the car-top working platform and at the 1-meter high position above the pit bottom.
19.	Make holes in the walls of a hoistway for Fujitec's installation of machine support beams and fill concrete into the gap between the walls and the fixed beams.
20.	Cut out landing walls and install emergency operation panels for Fujitec's emergency access to and operation of elevator machine and brake.
21.	Install machine lifting hooks and / or beams on the hoistway's ceiling slabs. The required lifting load capability is stated on the relevant installation drawings.

Others

1	Ground-fault circuit interrupter and current leakage alarm are required to be protected against current-harmonic distortion.
2	Lay building's telecommunication lines 500 mm away from the electric feeder lines for elevator system.
3	Remove corroded metal materials from the hoistway.
4	Protect the hoistway against hazardous gas.
5	Prevent dust from accumulating in the hoistway.
6	Provide a storage room in order to stock elevator parts and installation materials.
7	Do not place any tools and materials not related to elevators in the hoistway.

GLOBAL OPERATIONS

Fujitec's Global Operations in 24 countries and Regions Delivers "Japanese Quality: Made in Fujitec" to Various Customers.



FUJITEC AMERICA, INC.



Big Wing (Japan)



Big Step (Japan)



FUJITEC INDIA PRIVATE LTD.

In the 1960's, Fujitec became one of the first Japanese companies in the industry and sought for global development of its business. Since then, we have helped build cities all over the world and continue to develop our business aggressively on a global basis. Fujitec and its customers benefit from close relationships and cooperation among all of the members of Fujitec Global Companies.

● Sales Office
○ Production Base



NORTH AMERICA

FUJITEC AMERICA, INC.
FUJITEC CANADA, INC.

SOUTH AMERICA

FUJITEC ARGENTINA S.A.
FUJITEC VENEZUELA C.A.
FUJITEC URUGUAY S.A.

Delivering Japanese Quality Worldwide

Based on our global mission statement, "Respecting people, technologies and products, we collaborate with people from nations around the world to create beautiful and functional cities that meet the needs of a new age," Fujitec provides reliable products and services all over the world.

Integrated Global Quality Management

By developing technologies as a specialized manufacturer over the years, every Fujitec base has established an integrated quality management system for each stage of manufacturing, installation and maintenance. This supports Fujitec's constant pursuit of safety, reliability and comfort.



HUASHENG FUJITEC ELEVATOR CO., LTD.



SHANGHAI HUASHENG FUJITEC ESCALATOR CO., LTD.



FUJITEC KOREA CO., LTD.



FUJITEC TAIWAN CO., LTD.

FUJITEC
www.fujitec.com